



DIAMONDBACK



INSTALLATION GUIDE

CVR-270.1

90 minutes
Normal install time

Keep an eye out for these icons:

IMPORTANT!
Important installation information

Helpful Hints
Tips to assist installation

PARTS INCLUDED:

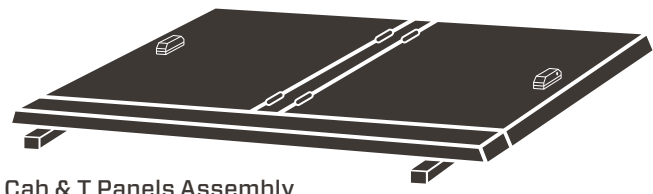

Cab & T Panels Assembly



Clamp Bracket

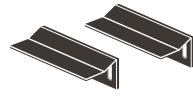

Lock-Rod Striker Brackets (2)



1/4" Self-Drilling Screws (8)



1/4" Rivet Nuts (8)



1/4" Lock Washers (8)

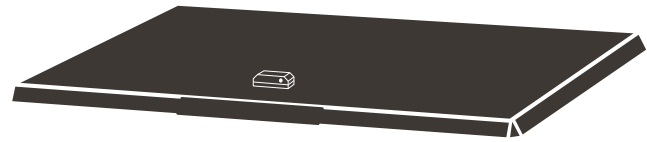

Tail Panel



Rivet Nut Installation Tool



1/4" Flat Washers (8)



1/4" Hex Bolts (8)



Cap Clamps (6)



Bed-Rail Edge Trim (2)



1/8" Hex Key



Gas Springs (6)

TOOLS REQUIRED:



Drill



3/8" Nut Driver Bit



25/64" Drill Bit



5/16" Drill Bit



Utility Knife



Ratchet Wrench, (Torque Wrench preferred)



9/16" Wrench



Rubber Mallet



9/16" Socket



7/16" Socket

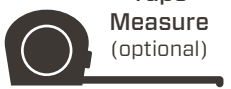

Tape Measure (optional)

PRE-INSTALLATION NOTES (REVIEW ALL OTHER INCLUDED INSTALLATION GUIDES BEFORE BEGINNING)

If your truck has a plastic bed liner, trimming is required for brackets/rivet nuts at the bulkhead.

Some models require bulkhead preparation first. Please refer to the instructions in the bulkhead prep kit prior to mounting the cover.

If your cover includes shims, affix the included bed rail shims first and reference their included instructions.

PREPARE THE CARGO BED

1 Referencing the image below, align the **clamp bracket (longer leg down)**, centered side to side between the bedrails, and flush with the top of the bulkhead. Attach using a drill, 3/8 nut driver bit, and included self leveling screws.

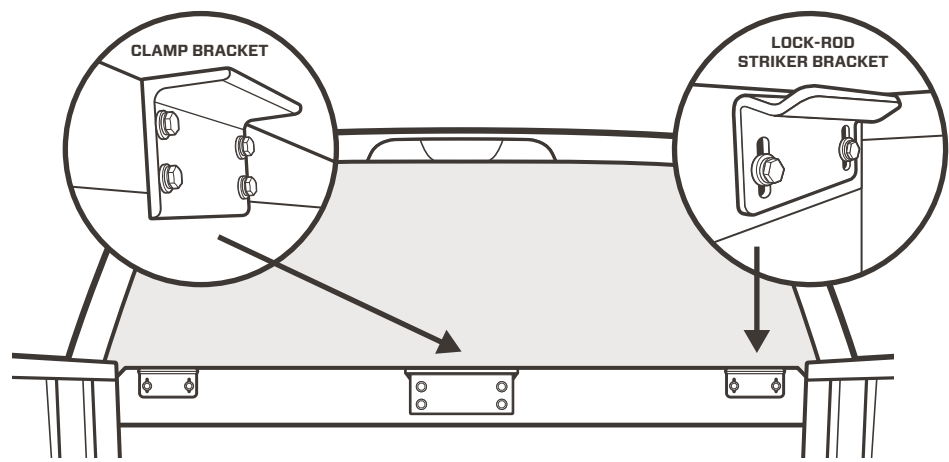

2 Using a drill, 3/8" nut driver bit, and the included self-drilling screws, attach a **lock-rod striker bracket** to each corner of the bulkhead (as shown above). Ensure the following:

- A. place the top edge of the bracket flush with the top of the bulkhead and
- B. drill your mounting holes as close to the vertical middle of the slots as possible.

! You may need to shift lock-rod striker bracket slightly inward from the bedrail, to keep flat with bulkhead surface.

3 Detach all three brackets by removing the self-drilling screws and set aside. Use the 25/64" drill bit to enlarge the holes in the bulkhead left by the self-drilling screws.

! Protection is needed to avoid drilling directly into the cab. Create a physical stop on the drill bit or place protection between the bulkhead and cab to prevent damage.

4 Thread a rivet nut onto the **rivet nut installation tool**. Hand-tighten until the hexagonal sleeve is tight to the face of the rivet nut. Next, using a rubber mallet, gently tap rivet nut into the pilot hole.

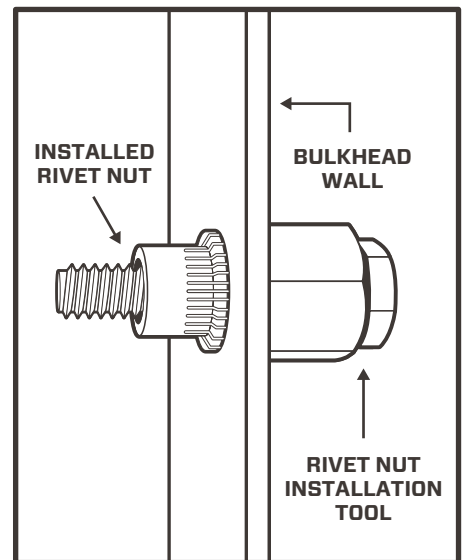
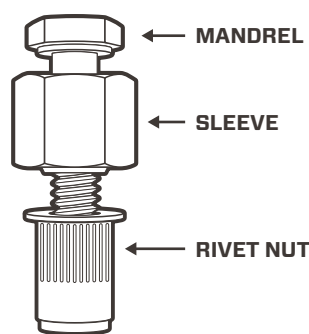

5 Use a 9/16" wrench to hold the sleeve of the **rivet nut installation tool** as you tighten the mandrel with a 7/16" socket until the rivet nut deforms and locks against the interior of the bed wall.

! At approximately 2 full revolutions, the nut should be tight. Do NOT overtighten or you will risk stripping the rivet nut.

6 Remove the installation tool by unscrewing the mandrel. Repeat steps 4-6 for each rivet nut.

7 With all rivet nuts installed correctly, reattach all brackets using the provided hex bolts and washers as shown. Tighten with a 7/16" socket, **ensuring not to overtighten** the bolts or you will strip the rivet nuts.

★ Re-installing the clamp bracket using the hex bolts and washers is easiest if you enlarge the holes in the clamp bracket using the 5/16" drill bit.

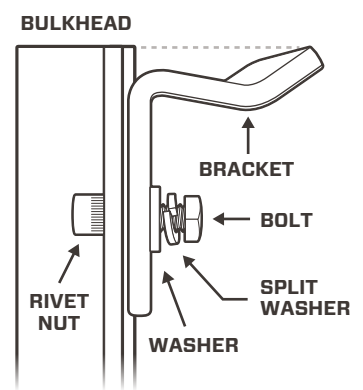

MOUNT THE COVER

8 Place the **cab & T panel assembly** on the front half of the bed.

9 Attach the tail panel by holding it at a 90° angle from the bed rails and mate the driver's side hinge first, followed by the passenger side's c-shaped hinge.

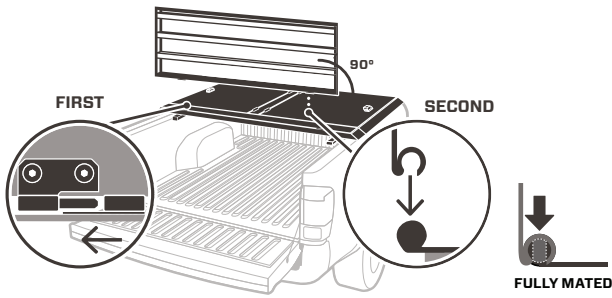

10 Position the cover front to back so that the front of the cab panels line up with the outside edge of the center of the bulkhead. Center the cover side-to-side on the truck.

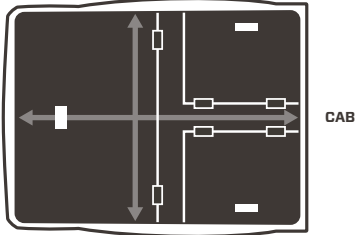

11 Secure the T panel to the truck by tightening two cap clamps under each of the three ends of the T panel.

Place the clamps' bottom jaws under the bed rails at the two sides and under the clamp bracket mounted to the bulkhead. Uniformly tighten the cap clamps using a 9/16" socket to between **5-6 ft-lbs**.

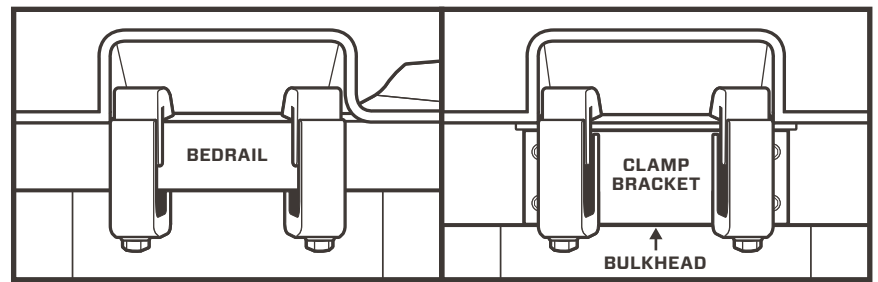

! While tightening clamps, be aware of possible bed rail cap deformation. Overtightening clamps will damage bed rail caps and cause leaking.

! Retighten after a week of use. Check them every time you haul on top.

PREP FOR THE LOCK RODS

12 Unbolt and move one of the bolts of the lock-rod guide brackets to the second, unoccupied slot using a 7/16" socket. Repeat this at each of the cover's bracket locations.

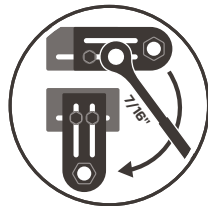

13 If your plastic bed rail cap extends below the metal edge of your bed rail, trim the excess at each lock rod location so that it's flush with the metal bed rail's edge.

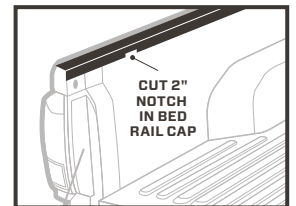

ADJUST THE LOCK RODS

14 Loosen the set screws for the tail and cab panel lock rods with the provided hex key and retighten each lock rod after ensuring the following...

CAB PANELS:

CORRECT ORIENTATION



HANDLE OPEN

HANDLE CLOSED

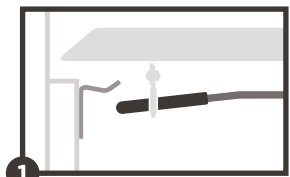

1 The angled orientation is always maintained

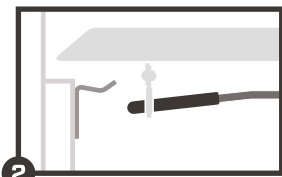

2 With the lock handle in the open position, the rod tips just clear the striker brackets.

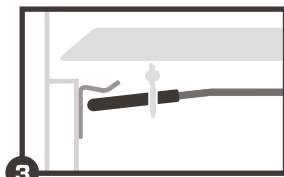

3 With the lock handle in the closed position, the lock rods are fully under the striker brackets and engaged as much as possible. Ensure the lock handle fully closes.

TAIL PANEL:

CORRECT ORIENTATION



HANDLE OPEN

HANDLE CLOSED

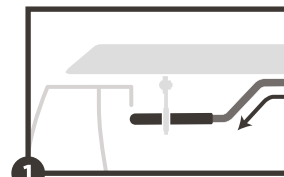

1 The Z bend orientation is always maintained

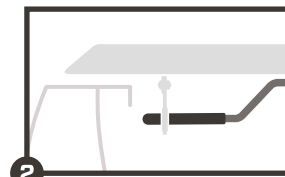

2 With the lock handle in the open position, the rod tips clear the bed rails.

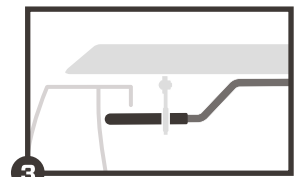

3 With the handle in the closed position, the rod tips do not hit the bed walls.

15 After properly aligning the lock rods in the closed position, it is time to tighten all brackets using a 7/16" socket. To ensure a tight seal, it is crucial to simultaneously push up on the bracket AND apply downward pressure on the cover. Repeat for all bracket locations.

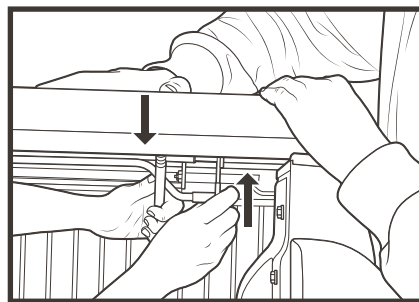

! The panels may be tough to open and close at first. Leave the panels closed as much as possible to allow the weatherstrip to break in. After a few days, you'll find things working smoothly.

! If you are also installing a bin, do so now. Refer to the bin's Installation Guide for details.

ATTACH THE BED RAIL EDGE TRIM

16 Peel the red adhesive backing from the edge trim pieces. Affix them to the metal bed rail in the correct orientation at the two points where the lock rods pass underneath.

★ Bed rail edge trim protects the lock rod end cap from wear, and helps draw the panels down and compress the weatherstrip. When installed properly, it will be a little tough to turn the lock handle at first.

★ Step 16 is unnecessary on '20-up Silverado & Sierra 2500 & 3500s and all '07-13 Silverados and Sierras.

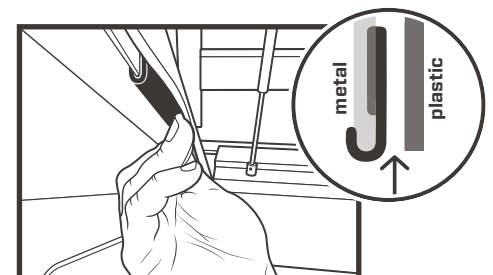

ATTACH THE GAS SPRINGS

17 Identify the 4 lighter gas springs and attach 2 to each **cab panel**.

! Make sure the barrel end is up. If you install your gas springs upside down, they'll fail.

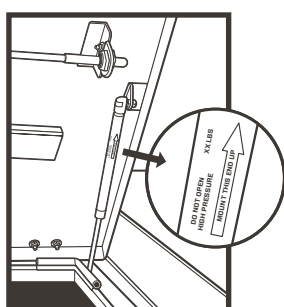

18 Attach the 2 remaining gas springs on the **tail panel**, again making sure the barrel end is up.

19 Leave the cover closed and locked for 24 hours to allow the pressure-sensitive weatherstrip adhesive to fully cure.

24 hours
Adhesive cure time

For first 2 weeks after installation
open tail panel on cover before operating tailgate.

